



Using Oscilloscopes in Serial Bus Decoding and Analysis



GW INSTEK

Made to Measure Since 1975

Preface

The communication quality of low cost, high speed transmission and high reliability is always demanded in the industrial control applications. Currently predominant protocol generally adapts serial or parallel mode. Especially the serial protocol is widely used in embedded products. The typical integration of the serial bus includes universal asynchronous receiver transmitter bus (UART), synchronous peripheral interface (SPI) and the internal integrated circuit (I²C). The GW Instek GDS-3000 Series oscilloscope is an oscilloscope with optional serial bus analysis. Users simply set the trigger conditions to perform the UART, I²C and SPI decoding and analysis.

As shown in Fig.1, the user can use the GW Instek GDS-3000 serial bus analysis function to quickly configure and obtain measurement results.

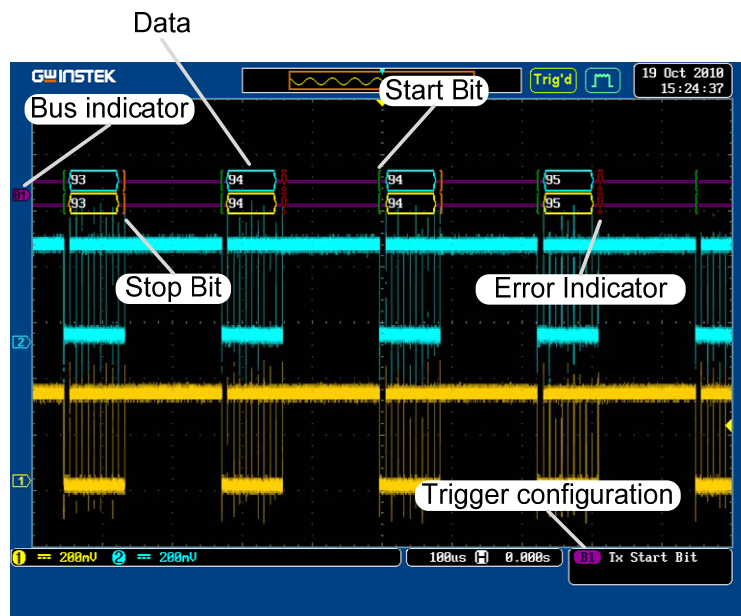

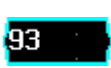



Fig. 1 Illustration for the GDS-3000 serial bus analysis

Fig 1 is explained as below:

Start Bit		The Start bit is shown as a green bracket.
Stop Bit		The Stop bit is shown as an orange bracket.
Data		Data packets can be shown in Hex or Binary. The color of the packet is the same as the channel color.
Error Indicator		If there is an error in decoding the serial data, an error indicator will be shown.

Bus Indicator	The Bus indicator shows the bus position. The active bus is shown with a solid color. The Variable knob can be used to horizontally position the Bus indicator when it is active.	
	B1 Active bus (B1)	B1 Activated bus (B1)
Trigger Configuration	Shows the bus trigger (<i>B1/B2</i>) and the <i>Trigger On</i> settings.	
	B1 Tx Start Bit	

Introducing UART, I²C and SPI and related applications on oscilloscopes

UART

UART, standing for the Universal Asynchronous Receiver / Transmitter short, is an asynchronous receiver transmitter. The Hardware is used to converse transmission of data between the serial communication and the parallel communication. UART is usually used in link with other protocols (such as EIA RS-232).

UART includes interface standard specifications such as RS232, RS449, RS423, RS422 and RS485 and bus standard specifications, which is the standard corresponding to variety of asynchronous serial communication interface standards and bus standard. It provides the electrical characteristics, transmission rate and connection characteristics of the communication. Actually it belongs to the physical layer (bottom) concept of communication network. It has no direct relationship with the communication protocol. The communication diagram is shown as in figure 2. The UART test and decoding in the GDS-3000 is shown in Figure 3 and Figure 4.

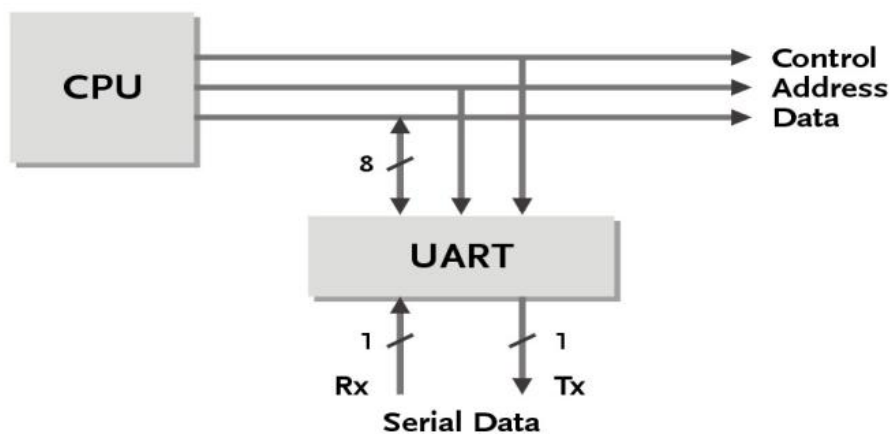

Fig.2 Illustration of UART control

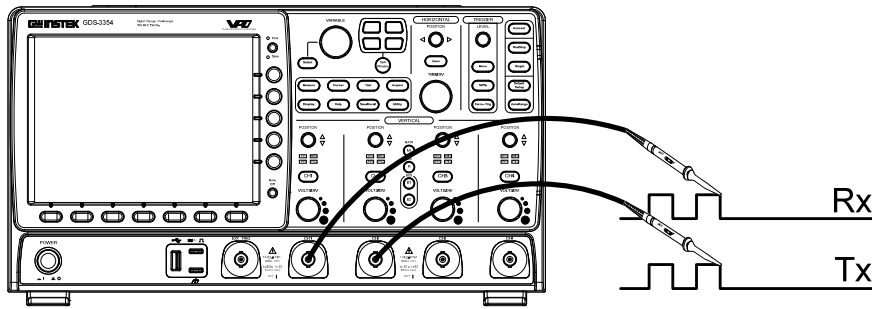

Fig. 3 Illustration of the GDS-3000 testing in UART

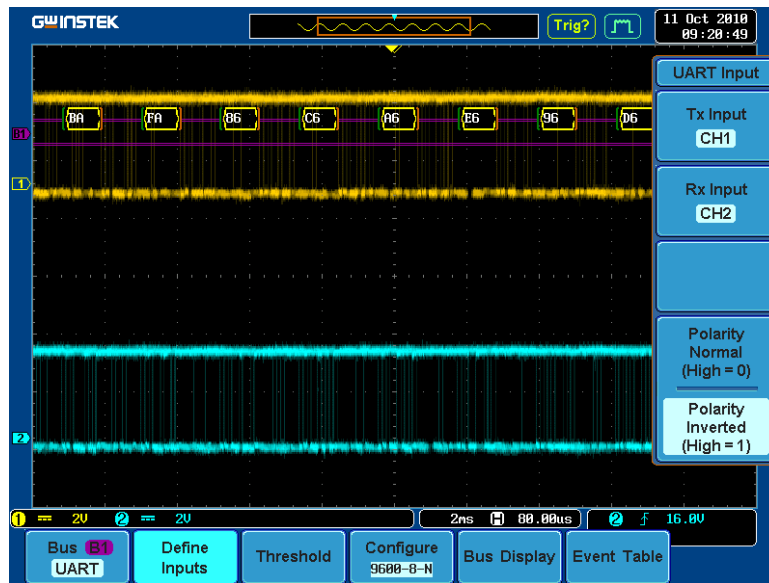

Fig. 4 Illustration of the GDS-3000 UART decoding

I²C

I²C (Inter-Integrated Circuit) bus was developed by PHILIPS in the early 1980s. The original purpose for this bus is to allow the CPU chip and chip in the TV set to connect more easily. At First, it was widely used in development of the audio and video. Now it is mainly used in server management, temperature sensing, voltage level conversion, EEPROM, general IO interface, A/D and D/A conversion, voice coding (CODEC), micro-controller. It contains the communication of the individual components status. The administrator can query for each individual component to manage the system configuration or control the functional state of each component such as power supplies and system fans. It can always monitor various parameters such as memory, hard drive, network, system temperature, etc. to increase the security of the system for easily management.

The data rate is selectable from 7bit addressing 100kbts/s or high-speed 10bit addressing 3.4Mbits/s.

Made to Measure Since 1975

I²C's features include:

- Half duplex bus. Only two signal cords are needed: Serial Data cord (SDA) and serial clock line (SCL)
- Each connected component in the bus has an independent and unique addressing. The addressing for complex system is controlled by software and need not to use hardware circuit for carrying out the address decoding.
- Supports multi-master bus.
- Collision detection is controlled by the software.

Illustration is shown as Fig. 5.

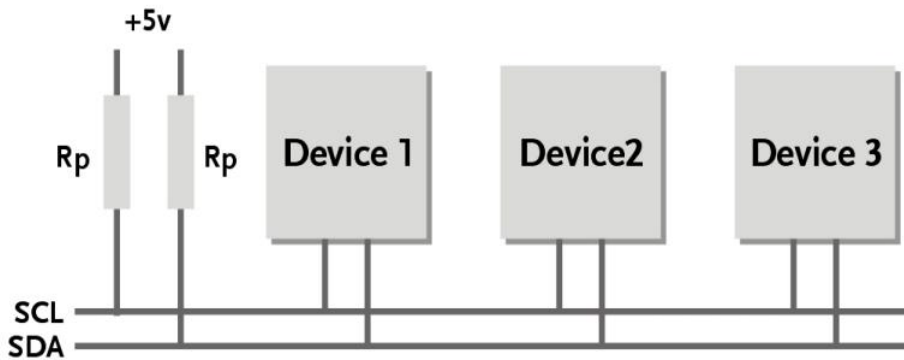

Fig. 5 Illustration of I²C control

Through the I²C decoding function of the GDS-3000, I²C signals can be analyzed in real time. The testing illustration and decoding result are shown in Fig. 6 and 7.

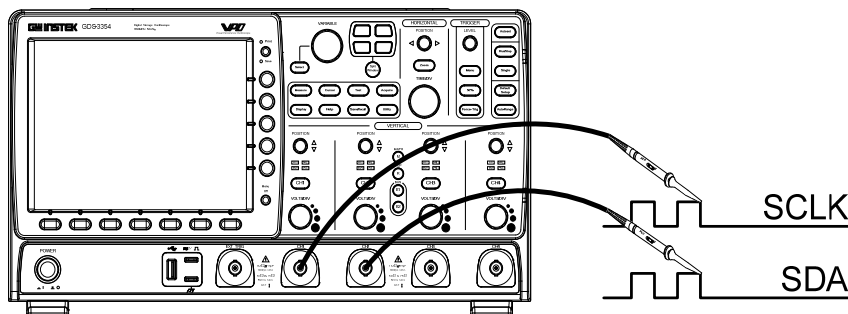

Fig. 6 Illustration of the GDS-3000 testing in I²C



Fig. 7 Illustration of the GDS-3000 I²C decoding

SPI

Serial peripheral interface, similar to I²C, is a 4-wire synchronous serial data protocol, which is suitable for use in portable device platform devices, but it is not as common used as I²C. Serial peripheral interface is generally in form of 4-wire, but sometimes 3-wire too. Therefore, 4-channel oscilloscope is needed for completing the SPI test requirements.

The full name for the standard signal are as follows:

SCLK - Serial Clock (output from the control terminal)

MOSI - Master Output Slave Input (output from the control side)

MISO - Master Input Slave Output t (output from the terminal been controlled)

SS - Slave Select (Low Level action, output from the control terminal)

Users can control the SPI Slave through the SPI Master, wiring diagram is in Fig. 8. The illustration of the GDS-3000 is shown in fig. 9.

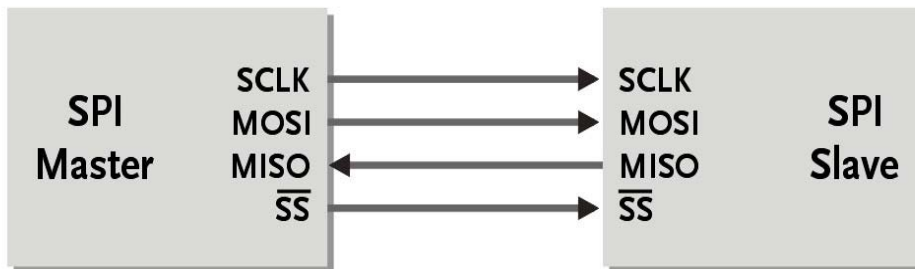

Fig. 8 Illustration for SPI control

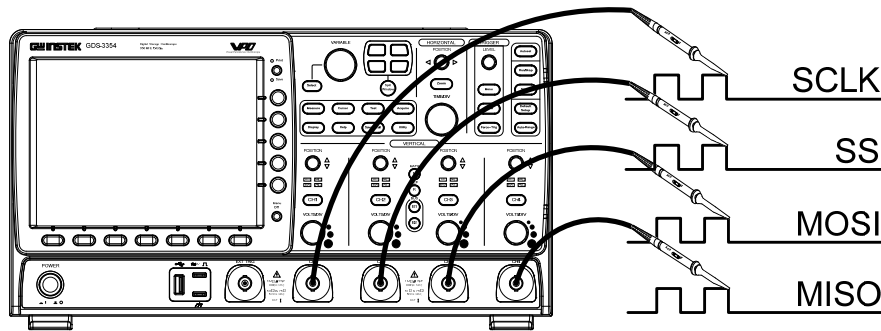

Fig. 9 Illustration of the GDS-3000 testing in SPI

GDS-3000 also equips with SPI decoding. Its decoding and analysis result is shown as Fig. 10.

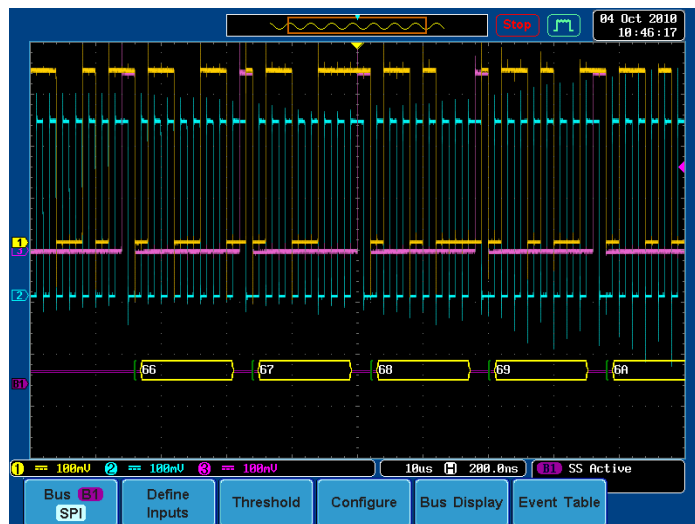

Fig. 10 Illustration for the GDS-3000 SPI decoding

Summary

By using serial bus decoding and analysis function in the GW Instek GDS-3000, users can select UART, I²C and SPI decode function easily through the buttons on the front panel. Speedy decoding and analysis capabilities can quickly reduce the measurement time.

With its diverse functionality, the GDS-3000 is the best C/P solution for waveform analysis and decoding among 150MHz ~ 350MHz oscilloscope.



GDS-3000 Series Introduction

GDS-3000 series is an innovative testing platform providing up to 350 MHz bandwidth, 4 analogue input channels, 5GSa/s, and VPO technology (Visual Persistence Oscilloscope). Beside these, it also equips an innovative split screen system with independent horizontal settings, vertical settings and triggers. This is a new function which can be used in testing, research, and manufacturing. With power analysis and serial bus analysis software, GDS-3000 series also enables engineers to expedite product testing, developing, and manufacturing.

Features

- * 350/250/150MHz with 2/4 Channels
- * 5GSa/s RT or 100GSa/s ET Sampling Rate
- * Independent Memory for Each Channel
- * VPO Technology
- * Large 8-inch 800x600 Display
- * Split Screen Function
- * 3 Built-in Impedances (50Ω/75Ω/1MΩ)
- * Power Analysis Software (Optional)
- * Serial Bus Analysis Software for I2C, SPI and UART (Optional)

GDS-3000 series						
	GDS-3152	GDS-3154	GDS-3252	GDS-3254	GDS-3352	GDS-3354
Channels	2Ch + Ext	4Ch + Ext	2Ch + Ext	4Ch + Ext	2Ch + Ext	4Ch + Ext
Bandwidth	DC~150MHz (-3dB)		DC~250MHz (-3dB)		DC~350MHz (-3dB)	
sampling rate	2.5GSa/s	5GSa/s	2.5GSa/s	5GSa/s	5GSa/s	5GSa/s
memory length	25k points					

For more information about product, power analysis software, and its corresponding accessories, please visit our website:

<http://www.gwinstek.com/en/product/productdetail.aspx?pid=3&mid=7&id=1290>

Global Headquarters

GOOD WILL INSTRUMENT CO., LTD.

No. 7-1, Jhongsing Road, Tucheng City, Taipei County 236, Taiwan
T +886-2-2268-0389 F +886-2-2268-0639
E-mail: marketing@goodwill.com.tw

China Subsidiary

INSTEK ELECTRONIC (SHANGHAI) CO., LTD.

8F, of NO.2 Building, No.889 Yishan Road, Shanghai China
T +86-21-6485-3399 F +86-21-5450-0789
E-mail: marketing@instek.com.cn

Malaysia Subsidiary

GOOD WILL INSTRUMENT (M) SDN. BHD.

27, Persiaran Mahsuri 1/1, Sunway Tunas,
11900 Bayan Lepas, Penang, Malaysia.
T +604-6309988 F +604-6309989
E-mail: sales@goodwill.com.my

U.S.A. Subsidiary

INSTEK AMERICA CORP.

3661 Walnut Avenue Chino, CA 91710, U.S.A.
T +1-909-5918358 F +1-909-5912280
E-mail: sales@instek.com

Japan Subsidiary

INSTEK JAPAN CORPORATION

4F, Prosper Bldg, 1-3-3 Iwamoto-Cho Chiyoda-Ku,
Tokyo 101-0032 Japan
T +81-3-5823-5656 F +81-3-5823-5655
E-mail: info@instek.co.jp

Korea Subsidiary

GOOD WILL INSTRUMENT KOREA CO., LTD.

Room No.805, Ace Hightech-City B/D 1Dong,
Mullae-Dong 3Ga 55-20, Yeongduengpo-Gu, Seoul, Korea
T +82 2 3439 2205 F +82 2 3439 2207
E-mail : gwinstek@gwinstek.co.kr

DISTRIBUTOR :